

Introduction

Turbidity is commonly used as a measure of water quality. It is a measure of the light scattering properties of the water and gives an indication of how clean the water is. It can be used for this purpose because scattering is caused by the presence of particles within the water. These particles can be inorganic solids, microorganisms, sands, soils, colloids and organic matter. There is also a small amount of scattering at a molecular level. This means it is impossible to get a true sample with no turbidity.

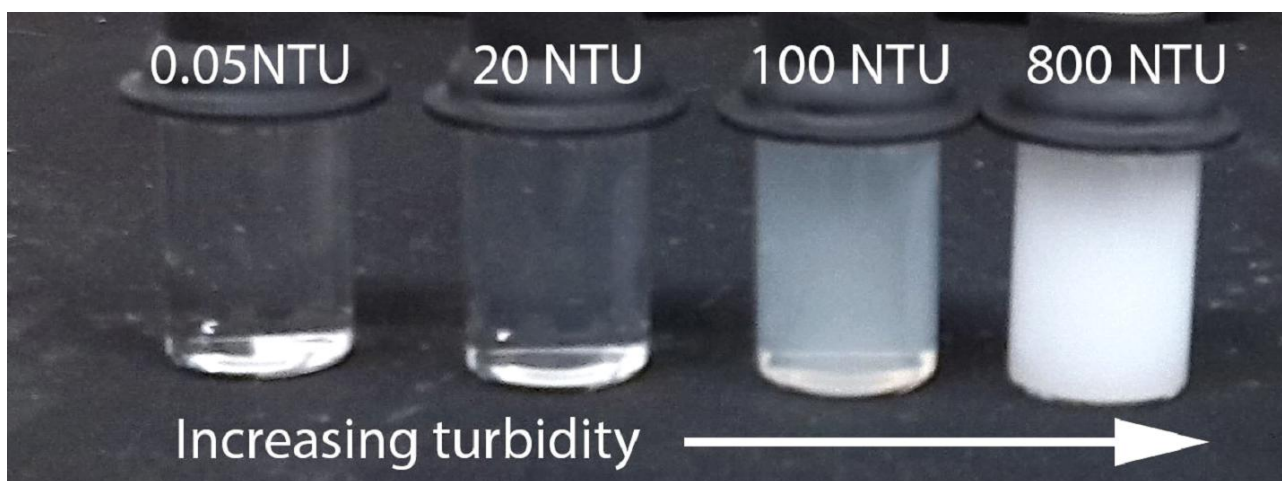

Fig. 1 - Examples of solutions with different turbidities.

Factors Affecting Turbidity

There are a number of factors which affect turbidity:

- **Particle Size** - small particles ($<0.06\mu\text{m}$ - $1/10$ th wavelength of light) scatter light in largely similar amounts in all directions, whereas larger particles ($>0.15\mu\text{m}$ - $1/4$ th wavelength of light) scatter more light in the forward direction due to additive interference between light scattered from different parts of the particle.
- **Incident Light** - small particles scatter shorter wavelengths more than longer wavelengths whereas larger particles scatter longer wavelengths more than shorter wavelengths.
- **Particle Shape** - spherical particles will cause a higher proportion of forward scatter compared to backward scatter than rod shaped or coiled particles.
- **Particle Color** - colored particles will absorb light of particular wavelengths which can reduce the size of the signal reaching the detector.
- **Particle Refractive Index** - the bigger the difference in refractive index between the particle material and water the more scattering

that will occur.

- **Particle Concentration** - scattering intensifies as the concentration increases. The amount of secondary scattering and adsorption also increases which eventually causes a reduction in signal.

Measuring Turbidity

Historically turbidity was measured using visual methods, such as the Jackson candle. This method involved a candle and a glass bottomed tube. The tube was filled with sample until the image of the sample flame had diffused into a uniform glow. This was one of the first methods to quantify turbidity and lead to the definition of the Jackson Turbidity Unit (JTU). Other visual methods such as a Secchi disc or a turbidity tube still see some use.

Modern instruments measure turbidity by illuminating the sample with a light and measuring the light scattered by the sample using a photodetector. The more particles present in the sample, the higher the scattered signal. Whilst any angle can be used for making the scatter measurements, including 0° which is transmission straight through the sample¹, many

¹ If measuring transmission, the signal will reduce with increasing particle concentration.

international standards, such as ISO 7027, specify the use of nephelometric measurements for the quantitative determination of turbidity. Nephelometry refers to the measurement of scattered light at an angle of 90°. This angle is used as it is most sensitive to scatter and is applicable for all particle sizes and shapes. Nephelometric measurements are the origin of the most commonly encountered unit used for turbidity measurement, NTU (Nephelometric Turbidity Unit)².

TurbSense

TurbSense measures turbidity by making a nephelometric measurement.

The sample is illuminated with an 860nm LED and the scattered light is detected at an angle of 90° using a photodiode.

The TurbSense has been carefully designed to give a high level of performance. This is achieved by collimating the LED light through a tube, to reduce divergence of the light within the sample and using a stepped probe end to stop light travelling directly to the detector. The 860nm near infra-red light source, as required by ISO 7027, minimises interference from sample color.

When a turbidity measurement is made the signal produced by the detector is composed of the scattered light due to particles in the water and also any background light present, together with any offsets due to the electronic components used. Electronic factors that can contribute to the detected signal include:

- **Dark Current** - the signal that the photodiode produces when no light is present.
- **Variation in Light Signal** - such as occurs due to the temperature dependence of the light output of an LED.
- **Coupled Noise** - interference due to other components within a sensor or external equipment causing a signal to be picked up by the detector circuitry.

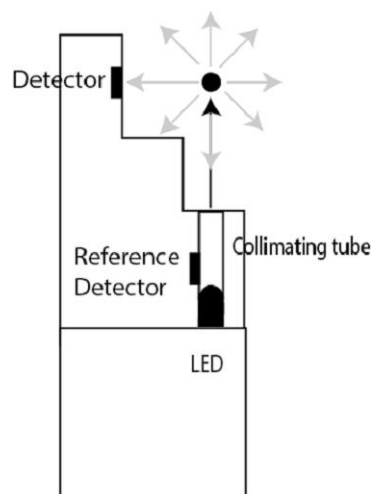

Fig. 2 - Illustration of Pi's TurbSense probe.



Fig. 3 - Pi's TurbSense probe.

In clean water, with few particles present, the signal produced by the scattered light will be low. If background light is present when the measurement is made, this can be a significant part of the measured signal.

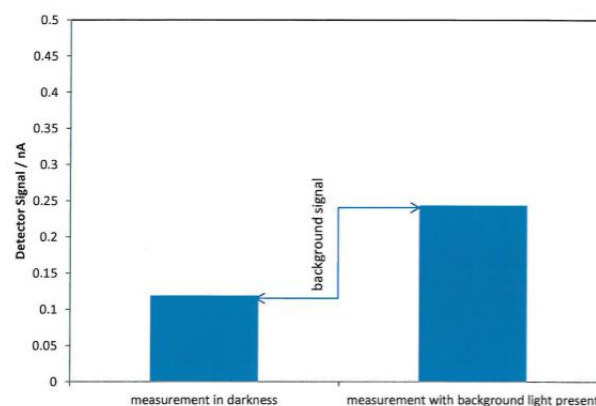

Fig. 4 - Effect of background on measured signal of tap water.

Figure 4 gives an illustration of this showing the size of the signals produced when tap water is analysed in systems with and without background light present. This difference can result in inaccurate results. A change in the background will cause the measured signal to change leading to an apparent change in the turbidity of a sample. The effect of background changes becomes even more significant if there is a difference between the background when the sensor is calibrated and when a measurement is made.

This is one of the reasons why the calibration of turbidity sensors is difficult. Many calibration procedures require a measurement to be made with a '0' NTU sample³. Such a sample is difficult to obtain, particularly on site, and the measurement of such a sample will be significantly affected by the background light levels.

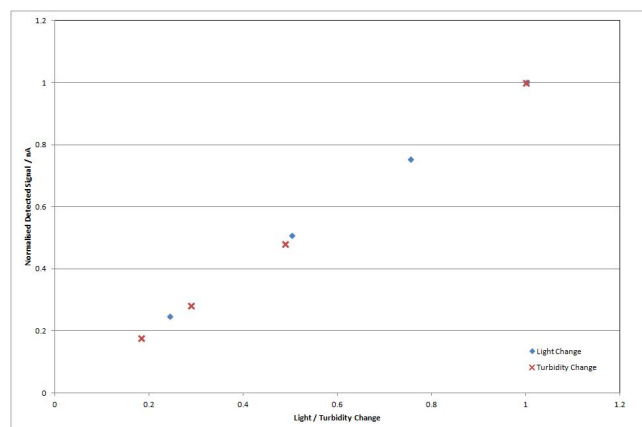

Fig. 5 - Effect of changing light output and turbidity on the detected signal. The turbidity was fixed when the light output changed and the light output was fixed when the turbidity was changed.

² The unit NTU is generally used for turbidity measurements but strictly only applies if a tungsten light source is used. For a near infra-red light source formazin nephelometric units (FNU) should strictly be used. The two units are approximately the same.

³ A true 0.000 NTU sample is impossible to achieve. Molecular scattering of water will give a turbidity of around 0.018 NTU.

To overcome these problems the TurbSense uses a new approach to making turbidity measurements that allows for simple calibration and gives stable results. The approach taken is to take measurements at different light levels. This can be done as changing the light levels has a similar effect on the detected signal to changing the turbidity of the sample. This effect is illustrated in Figure 5, which shows that changing the light level, for a fixed turbidity sample, has the same effect on the detector signal as changing the turbidity of the sample (for a fixed light level). This means that a calibration can be carried out using a single sample and reducing the light output to come up with a relationship between turbidity and detected signal.

Calibrating the TurbSense

To carry out a calibration the turbidity of the sample is measured by the detector signal together with the reference signal, which accurately measures the amount of light emitted. The light signal is then reduced to 75%, 50% and 25% power. The detector and reference signals are measured at each of these points. These points are plotted against each other, as shown in Figure 6, to allow the gradient to be calculated.

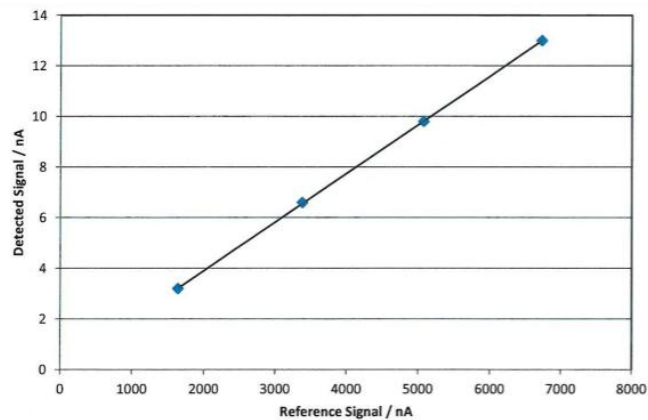

Fig. 6 - Calibration graph to determine the gradient of a TurbSense sensor.

By taking the readings in quick succession the backgrounds can be assumed to be identical. This means the gradient is independent of the background and is solely due to turbidity.

A sample with no turbidity will have no gradient, regardless of how much light is supplied to the system. This gives a fixed 0 point and means it is not necessary to make a '0' NTU measurement. The relationship between gradient and turbidity, as illustrated in Figure 7, can be established and then used to determine the turbidity of samples.

To make a sample measurement, the detector signal and reference signals are recorded at full light power and half light power. The gradient between these points is then used to give the sample turbidity.

A further benefit of using the reference signal within a measurement is that it reduces problems associated with temperature changes, something which commonly affects

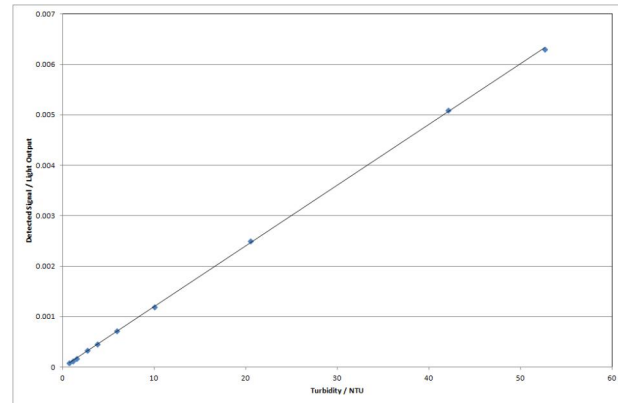

Fig. 7 - Relationship between gradient (detected signal/light output) and turbidity.

optical measurements. The light output is the factor that changes most with temperature and such changes will be picked up in both the reference signal and detector signal and cancelled out.

Using the calibration procedure with a single calibration allows the TurbSense to give accurate turbidity measurements across a wide range of samples. This is illustrated by the results shown in Figures 8 and 9 that show the comparison between the turbidity of a sample and the turbidity measured using TurbSense for a variety of samples.

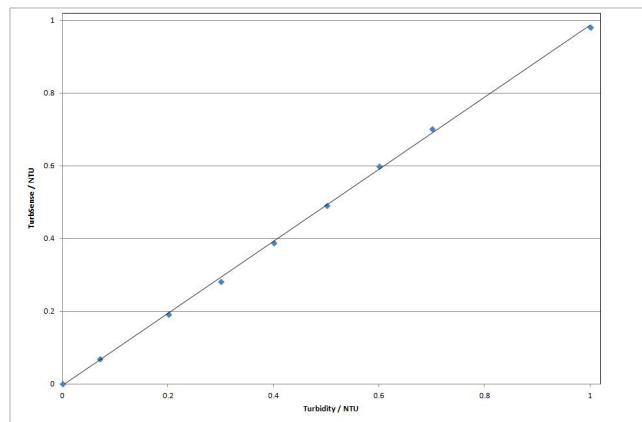

Fig. 8 - Comparison between sample turbidity and turbidity measured with TurbSense with low turbidity samples.

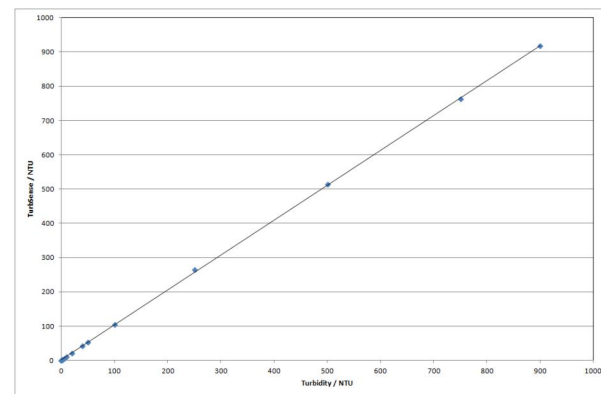

Fig. 9 - Comparison between sample turbidity and turbidity measured using TurbSense with samples with a wide range of turbidities.